

Assembly Instructions And User Guide

Nixie Clock Type 'Frank 2 IN-8-2'

Software version: RTC-1.3
PCB Revisions: 11 April 09, 14 Jan 10



1. INTRODUCTION

1.1 About the clock

Nixie clock type 'Frank 2' is a compact design with all components and tubes mounted on a single PCB. The efficient use of board space is achieved by using a multiplex design to drive the display tubes. Only a single high-voltage binary-to-decimal decoder IC (74141) is required, and each tube is switched on in sequence very quickly to give the illusion that all the tubes are actually lit.

The tubes are type IN-8-2 with a digit height of 18mm. These tubes are Russian in origin and were produced during the 1980's, when the technology was at it's most advanced. It is expected that the tubes will last for many years and should not need replacing.

1.2 Clock Features

Nixie clock type 'Frank 2' has the following features:

- Hours, Minutes and Seconds display
- Uses a Temperature Compensated Crystal Oscillator (TCXO) as the timebase
- Lithium coin cell backup / RTC. Keeps time during power outages
- Simple time setting using two buttons
- 12 or 24 hour modes
- Programmable leading zero blanking
- Five programmable neon colon settings (Flashing AM/PM indication, illuminated AM/PM indication, both flashing, both on, both off)
- Maintains time during setup mode, eg. When changing between Standard Time and Daylight Savings Time
- Seconds can be reset to zero to make small adjustments / precisely set time
- Infinitely programmable night time blanking period to save tubes
- Separate modes for colon neons during night time blanking
- Four display modes: Dim, Bright, Fading digits, Blanked
- Ten different possible fade speeds in fading digit mode

1.3 SAFETY

DANGER: The clock pcb includes a switched-mode voltage booster circuit. This generates nominally 170 Volts DC, but is capable of generating up to 300 Volts before adjustment. Assembly may only be undertaken by individuals who are suitably qualified and experienced in electronics assembly, and are familiar with safe procedures for working with high voltages. If in doubt, refer to a suitably qualified engineer before proceeding.

The voltages generated by this circuit can give a potentially LETHAL ELECTRIC SHOCK.

DISCLAIMER: This product is supplied as a kit of parts, intended only for suitably qualified electronic engineers, who are suitably qualified and experienced in electronics assembly, and are familiar with safe procedures for working with high voltages. The supplier, his agents or associates accept no liability for any damage, injury or death arising from the use of this kit of parts.

This is not a finished product, and the person assembling the kit is responsible for ensuring that the finished product complies with any applicable local regulations governing electrical equipment, eg. UL, CE, VDE.

2. TOOLS AND EQUIPMENT REQUIRED

2.1 Tools required to assemble the PCB

The following tools will be required to assemble the PCB:

- Soldering iron with a small tip (1-2 mm)
- Wire cutters (TIP: A small pair of nail clippers works very well for this function)
- Wire strippers (TIP: A small pair of scissors is quite suitable)
- Multimeter
- Small flat screwdriver for adjusting the high voltage supply

2.2 Materials you will need

Solder – lead / tin solder is preferred. Lead – free solder, as now required to be used in commercial products in Europe, has a much higher melting point and can be very hard to work with.

Desoldering wick (braid) can be useful if you accidentally create solder bridges between adjacent solder joints.

2.3 Other items you will need

The clock kit does not include a power adapter. This is because the kit is sold to many countries around the world, each with very different household mains outlet socket types. It is more efficient for the user to buy a suitable adapter locally. This saves shipping a heavy adapter with the kit, and also the extra costs of managing stocks of many varied power adapters.

The type of power adapter can be obtained at very low cost. The following type of adapter should be obtained and used with the kit:

Output 9-12V AC OR DC

Minimum power output capability of 250 mA

Output plug: 2.1mm pin

A suitable adapter is shown in figure 1 below:



Figure 1

3. LIST OF COMPONENTS

3.1 Table of components (In sequence)

Circuit Designation	Part Description
Resistors	
R1	33K, ¼ Watt
R2	1K, ¼ Watt
R3	1K, ¼ Watt
R4	390K, ¼ Watt
R5	1K, ¼ Watt
R6 – R11	390K, ¼ Watt
R12 – R23	5.6K, ¼ Watt
R24 – R29	Wire link
R30, R31	390K, ¼ Watt
R32 - R34,	33K, ¼ Watt
R35	Not installed
R36, R37	33K, ¼ Watt
Capacitors	
C1	470uF, 16-25V, Electrolytic
C2	100uF, 16-25V, Electrolytic
C3	470uF, 16-25V, Electrolytic
C4	22nF ceramic or polyester
C5	1uF, 250V, Electrolytic
C6	Not installed
C7 – C12	100nF ceramic
Transistors	
Q1	MPSA42 NPN
Q2	IRF730 N-Channel MOSFET
Q3-Q8	MPSA92 PNP
Q9-Q16	MPSA42 NPN
Diodes	
D1-D4	1N4001
D5	1N4936 fast recovery diode
D6	Not installed
Integrated Circuits	
IC1	78L05 5V voltage regulator
IC2	NE555 Timer IC
IC3	PIC16F628A 8-bit Microcontroller
IC4	74141 / K155N Nixie driver
IC5	DS3231 TCXO / RTC
Miscellaneous	
L1	100uH – 470uH Inductor
NX1-NX6	Nixie tube IN-8-2
SW1, SW2	Miniature push button
NE1, NE2	4mm wire ended neon
VR1	1K Potentiometer
PCB	PCB
IC Socket	18 Way IC Socket for IC3
BATT	CR1220 Cell + Holder
CONN	2.1mm PCB Power socket

3.2 Parts list / Packing sheet

Part Description	Quantity
Resistors	
1K, ¼ Watt	3
5.6K, ¼ Watt	12
33K, ¼ Watt	6
390K, ¼ Watt	9
Capacitors	
470uF, 16-25V, Electrolytic	2
100uF, 16-25V, Electrolytic	1
1uF, 250V, Electrolytic	1
100nF, ceramic	6
22nF, ceramic or polyester	1
Transistors	
IRF730 N-Channel MOSFET	1
MPSA92 PNP	6
MPSA42 NPN	9
Diodes	
1N4001	4
1N4936 fast recovery diode	1
Integrated Circuits	
78L05 5V voltage regulator	1
NE555 Timer IC	1
PIC16F628A 8-bit Microcontroller	1
74141 / K155N Nixie driver	1
DS3231 TCXO / RTC	1
Miscellaneous	
100uH – 470uH Inductor	1
Nixie tube IN-8-2	6
Miniature push button	2
1K Potentiometer	1
4mm Wire ended neon	2
PCB	1
IC Socket, 18 way DIL	1
CR1220 Cell + Holder	1
Clear insulation for Neons	1
2.1mm PCB Power socket	1

It is recommended that the kit is checked against the list above, to ensure all parts are present before commencing assembly.

3.3 How to identify the correct components

Resistors:

The resistors are easy to identify by the coloured bands across the cylindrical body. Using a multimeter it should be possible very quickly to identify the different values.

Capacitors:

Take care when identifying the small ceramic or polyester capacitors. Depending on part availability, 2 or more different types may be supplied. The 22nF capacitor (C4) may be marked 22nF, 22n, or 223. The 100nF capacitors (C7-C12) may be marked 104.

Transistors:

The MOSFET Q2 can easily be identified as it has a large metal heatsink. Note: Due to part availability, this part may be substituted for a different but equivalent part number so the part marking may not necessarily be 'IRF730'

Diodes:

The four 1N4001 diodes D1-D4 are black and are marked 1N4001. 1N4007 diodes may be supplied instead. They are identical for this circuit. The other black diode is D5, and again due to part availability it may be substituted for an equivalent.

Inductor L1

The inductor is a coil winding on a ferrite core and may or may not be finished with a heatshrink sleeve depending on part availability

4. ASSEMBLY OF THE PCB

4.1 Diodes D1-D4

Start by bending the leads of the four diodes to approximately match the spacing of the holes on the PCB. Insert the four diodes taking care to match up the white bands on the components with the component marking on the PCB. See Figure 2 below.



Figure 2

Solder in the diodes, then using the wire clippers trim off the leads.

4.2 Diode D5

D5 is the remaining black diode. Again noting the position of the white band, place in position, solder in and trim the leads.

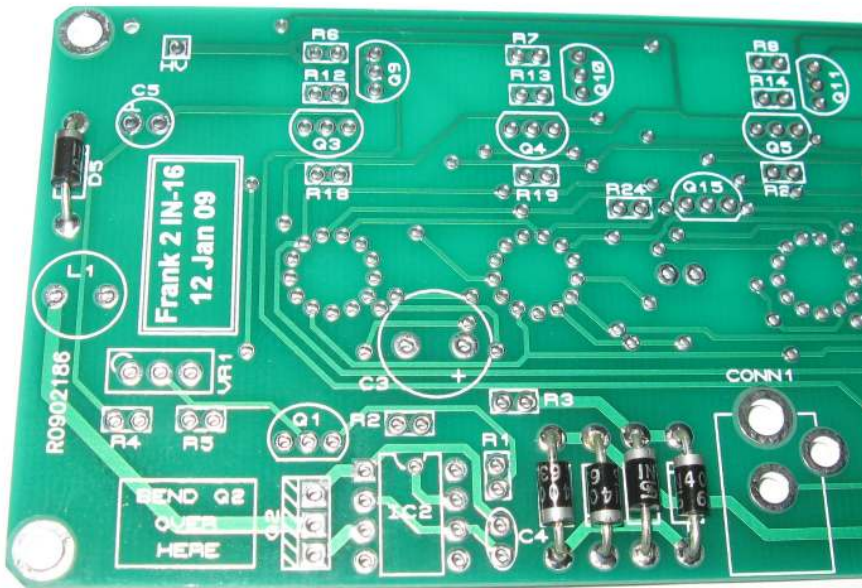

Figure 3

4.3 IC2 and C4

IC2 must be oriented correctly. The notch or dot at one end corresponds to pin 1. This goes into the SQUARE pad. Also place and solder in C4.

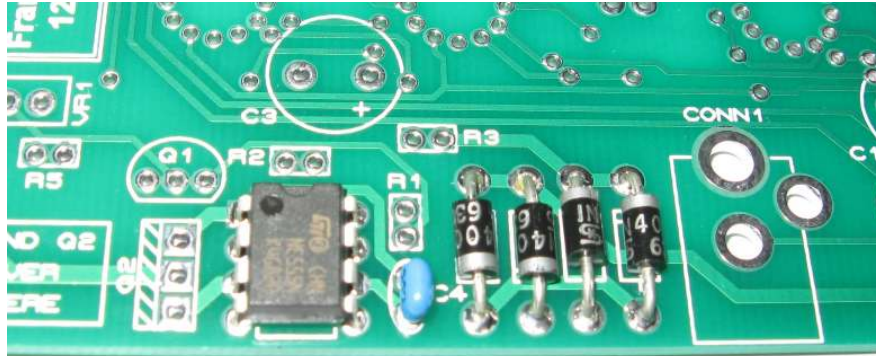

Figure 4:
IC2 and C4

4.4 IC1 and Q1

IC1 and Q1 look very similar, so be careful to identify them correctly by the white marking on each component. The leads should not need to be formed, just separated a little. Align the flat of the body of these components with the marked flat on the PCB. Push each component into its holes until the body is just 2 mm from the PCB. Solder in and trim the leads.

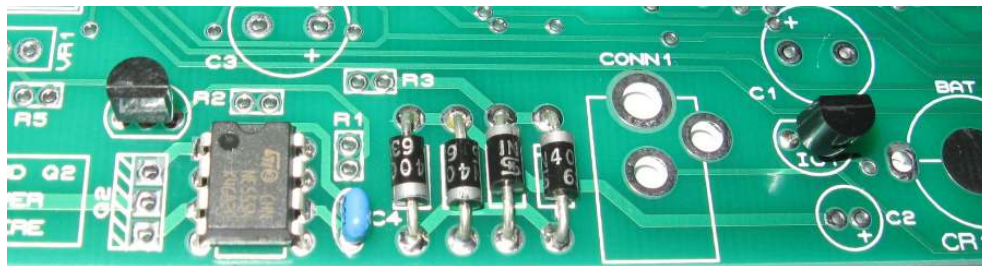

Figure 5: Q1 (left) and IC1 (right)

4.5 MOSFET Q2

The board is very densely populated in this area. Depending on your chosen case design, you may wish to bend the leads of MOSFET Q2 to make the profile lower.

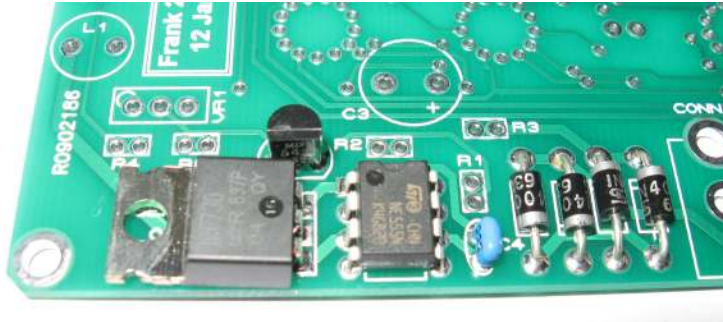

Figure 6: Bending the leads of MOSFET Q2 to lower the profile of the board.

4.6 R1, R2, R3, R4, R5

These resistors, indeed all the resistors on the board need to be mounted upright to save space. The leads need to be formed as shown in figure 7. Bend the leads of each resistor as shown and solder in to the correct position, making sure the component body is as close to the board as possible.



Figure 7: Resistor leads formed for mounting upright.



Figure 8: R1 to R5 placed vertically

4.7 Variable Resistor VR1

VR1 is used to tune the switched mode power supply to give the optimum voltage to drive the Nixie tubes (170-180V).

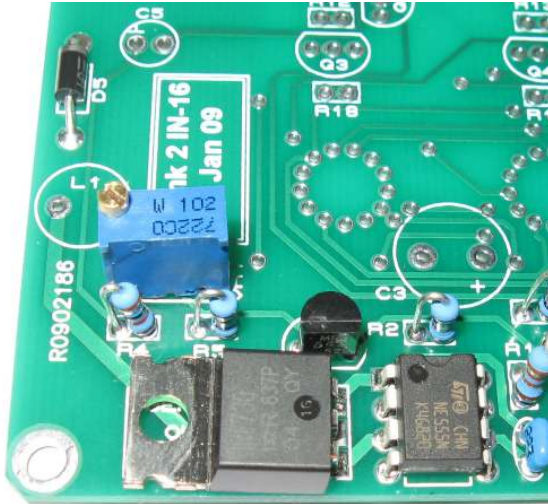

Figure 9 showing VR1

4.8 Inductor L1

Place L1 in position, and ensure it is as close to the board as possible. The leads of the component may not match exactly the spacing on the board – this is perfectly normal. You can slightly form the leads so it is a nice firm and snug fit to the board. Solder and trim the leads as short as possible.

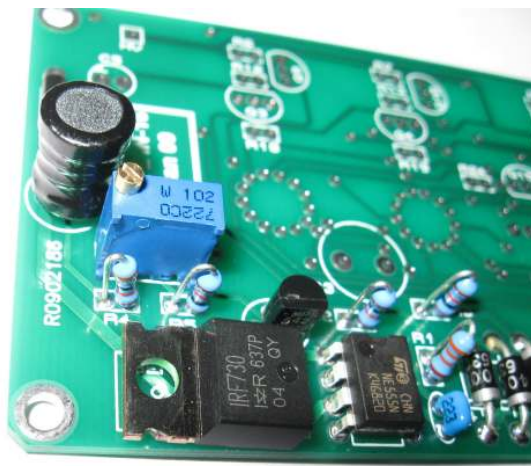

Figure 10

4.9 C1, C2, C3 and C5

Now it is time to solder in these four electrolytic capacitors. These components must be placed the correct way round or else the circuit will fail. Each capacitor has a positive lead, which has the longer lead, and a negative lead, marked by a white or grey stripe on the body. In Figure 11, the longer lead (+ve) and white stripe (-ve) can be clearly seen.

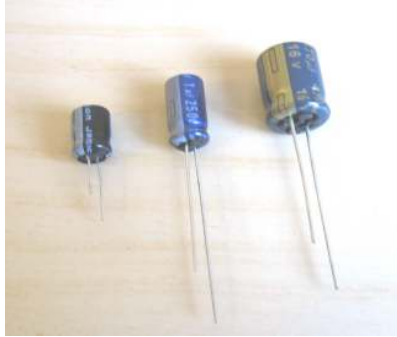

Figure 11: Electrolytic capacitors

Place each component as shown in figure 12 below, with the longer lead in the hole marked '+'. Solder in and trim the leads.



Figure 12: Electrolytic capacitors placed on the PCB

4.9 Power Connector CONN1

Place the power connector in position (figure 13), and solder in place. Try not to use too much solder which could flood through and cause shorts. Just lightly solder each tab to one side of its hole (figure 14).



Figure 13: CONN1



Figure 14: Underside view of CONN1

4.10 Testing the Switched mode (170V) and regulated (5V) power supplies.

If you have reached this point and followed the correct order, then all the components for the 170V and 5V power supplies should now be on the board, and it is recommended that at this point the power supplies are tested before proceeding. To do so, you will need to have the 9-12V power adapter to hand. Also at this stage you will need a small flat blade screwdriver and a multimeter.

DANGER: At this point, observe the safety warnings in section 1.3. When powered up, the board will generate up to 300V DC, and live parts are exposed. Observe high-voltage precautions.

4.10.1 Testing the power supplies

First, check that the 5V supply is in order. Use the GND, 5V and 170V test points to test first the 5V supply, then the 170V supply. Adjust the position of VR1 until the voltage is 170V. Be sure to set your multimeter to DC setting.

When all is in order, disconnect the power supply. Take care, as the output capacitor can still hold charge at 170V after the supply is disconnected.

4.11 Socket for IC3, IC4.

Insert the 18 Way IC socket into the PCB, ensuring that the notch at one end is aligned with the corresponding mark on the PCB. Insert IC4 directly into the PCB. Solder both components in place, but do NOT insert IC3 at this stage. This will be inserted at the very end of the assembly. Refer to figure 15.

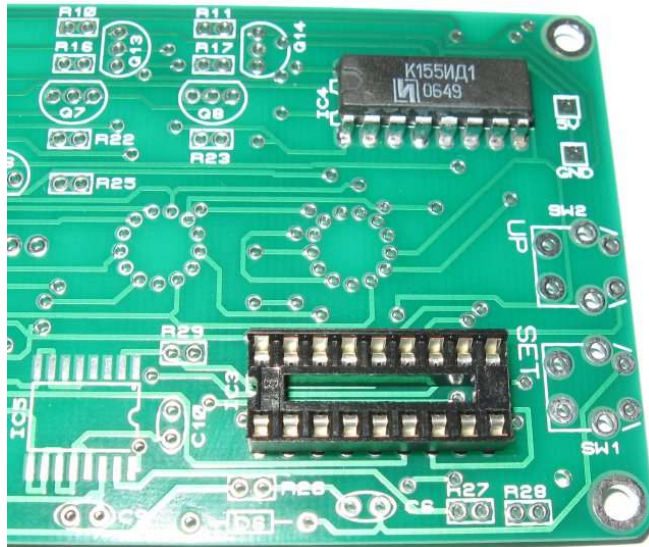

Figure 15: Socket for IC3, and IC4

4.12 Q3-Q8, Q9-Q14, R6-R23

This is perhaps the most time consuming stage of the assembly. There are six anode driver clusters. The function of each is to take the logic output from the 5V microcontroller, and switch on the 170V Anode drive to the respective nixie tube.

Pay particular attention to installing the correct transistor type (MPSA42 or MPSA92) in the correct location.

4.13 R24 – 29 Wire Links

No resistor is used at these points, so use wire links made by bending a short piece of wire trimmed from some of the resistors used above.

4.14 R30-34, R36, R37, Q15, Q16

Be sure to miss out R35 as it is not used for this design, as are C6 and D6.

4.15 Nixie tubes IN-8-2

To facilitate easy insertion of the flying leads into the small holes, it helps enormously to trim the flying leads with a pair of scissors as shown in figure 16. Start by identifying the gap between the two flying leads at the back of the tube.

Then, working around the tube, cut each successive lead approx 2mm shorter than the previous one. This will allow you to feed each lead in in turn.

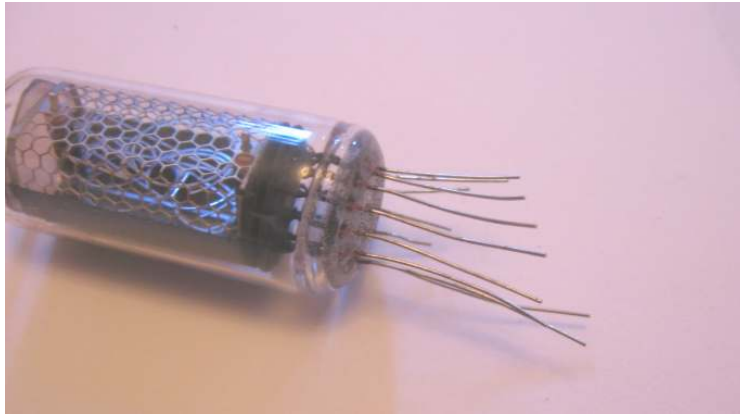

Figure 16: IN-8-2 flying leads trimmed to aid insertion into the PCB

Now you can insert and solder in the tubes, one at a time. PLACE THE TUBES ON THE OPPOSITE SIDE OF THE PCB TO THE COMPONENTS!! Feed all the wires in progressively. It is not as hard as it seems at first. After soldering in, trim flying leads.

4.16 SW1, SW2.

Push buttons SW1 and SW2 are mounted on the component side of the PCB, so that the clock is adjusted from the back (tubes are on the non-component side). You can also choose to mount them on the top face if you wish, depending on your own particular clock case design.

4.17 NE1, NE2.

The two neons can be installed now. Set at a height appropriate for the case you will be using. Use small lengths of the clear insulation supplied on the legs. This will prevent any short circuits.

4.18 C7, C8

These 2 filter capacitors are installed directly across the 5V and GND pins of IC3 and IC4 on the tube side of the PCB. Lie the component flat against the PCB.

4.19 C11, C12 These 2 filter capacitors are installed directly across the shorter sides of the 2 switches, to prevent any glitches causing the switches to falsely trigger.

5. INITIAL TESTING OF CLOCK – BEFORE IC5 INSTALLATION

All components should now have been installed, except the timekeeping components IC5, C9, C10 and the Lithium coin cell. Make a final check that all components are well soldered in, and that there are no solder bridges – unintentional solder links between adjacent pins.

Insert IC3, matching up the notch on the resin body with the notch on the socket and the PCB markings.

Power up the PCB, and check that the Nixie tubes light. They will light with a spurious number, as there is no time signal as yet. The important thing is that they light up. This gives a very good indication that all is well, and the remaining timekeeping components can be installed. If there is no sign of tubes lighting, do not proceed as you may damage the DS3231 IC. Contact support@pvelectronics.co.uk

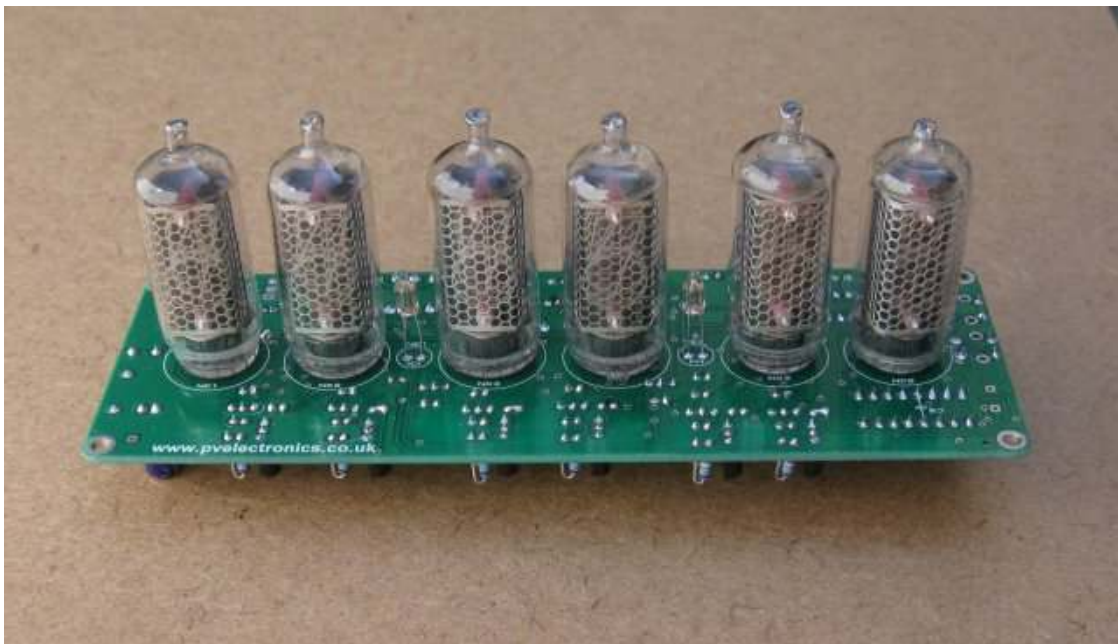

6. PLACEMENT OF THE TIMEKEEPING COMPONENTS

6.1 IC5 – DS3231

Clearly this is a surface mount device (SMD) and will be different and possibly more challenging to solder than a standard through-hole component. However, it is the largest pin-pitch SMD available and should be pretty straightforward to solder. Your PCB may look slightly different to the one pictured however the procedure is the same.

Use a fine-tipped soldering iron and fine flux-cored solder. Start by applying a small amount of solder to a corner pad:

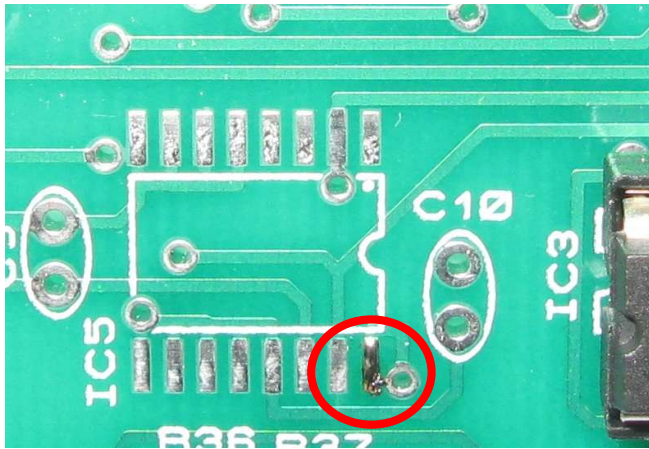

Figure 17: Corner SMD pad wetted with solder

Now, place the IC carefully in position ensuring it is straight, all pins are over the pads, and the notch or dot on the IC package is next to the notch on the PCB markings:

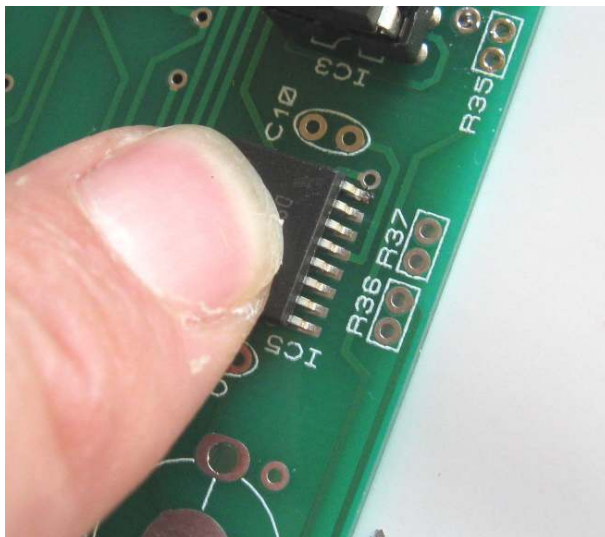

Figure 18: DS3231 placed and held firm

Holding the IC firmly in place with one finger as shown in figure 18 above, now touch the pin where the solder has been applied with the soldering iron. The solder will re-melt and anchor the IC.

Take care here, as the IC can still move somewhat. So next, solder the pad diagonally opposite the first pad. Then the IC will be held firmly to complete the soldering of the remaining pins. Do not worry about any excess solder or solder bridges between pins at first, concentrate on ensuring that each pin is soldered to the pad. Afterwards, go round using desolder braid (wick) and remove any bridges and excess solder.

6.2 C9, C10, Lithium coin cell holder

These can now be placed. The battery holder is a large metal component, and will dissipate the heat of the solder iron away very quickly so keep the iron on long enough for the solder to fully wet out the frame of the battery holder. Insert the coin cell with the + terminal upwards.

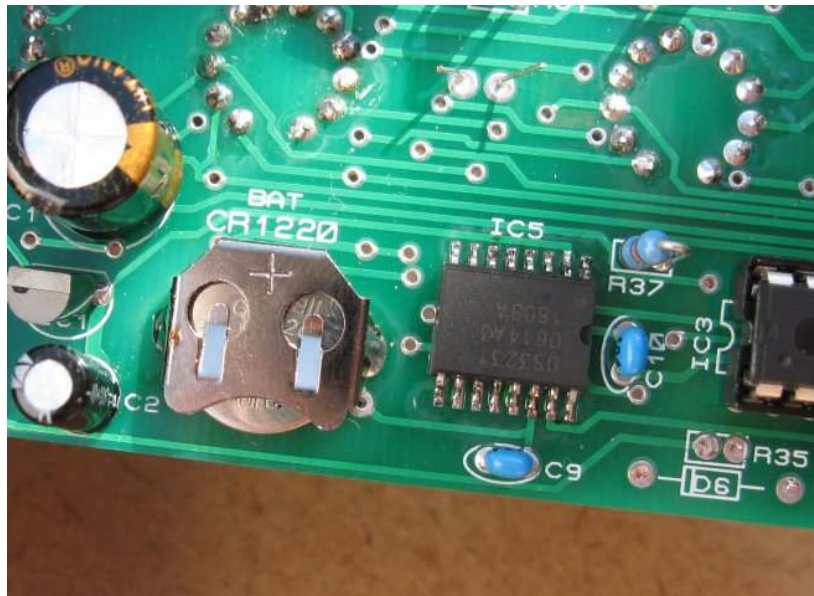

Figure 19: Showing all RTC components: IC5, C9, C10, Lithium Cell

6.3 Board Error

PCB Board dated 11 April 09 has a small error. There is a single 'via' missing from the PCB. (That's a plated hole connecting the top to the bottom). The via should be where all the grounds and 'No connects' from the DS3231 meet up – they should feed through to connect right up to the ground plane on the other face.

They are still grounded, but a long way round. They also need a ground close to the filter capacitor C10.

The solution is simple, and it immediately restores the accuracy of the DS3231. See attached figure 20 below. You insert a small wire from the hole shown and connect it up to the lead of C9 where it meets the ground plane.

The board error will of course be fixed in the next board production issue.

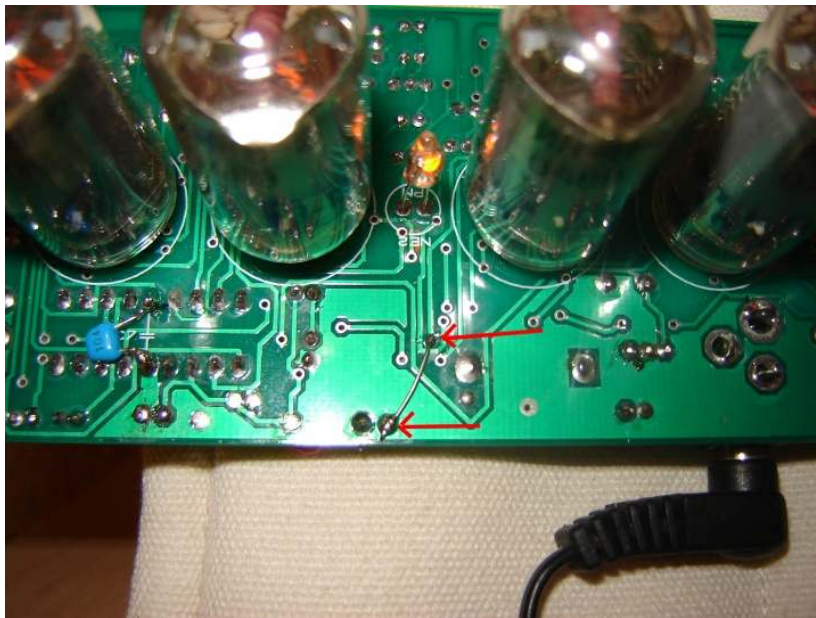

Figure 20: Fixing board error.

7. HOW TO OPERATE THE CLOCK

The two buttons have the following functions:

SW1: Set

SW2: Up / Reset Seconds

Entering configuration mode:

The principal settings of the clock are stored in flash memory – your preferred configuration is stored even after powering off the clock. To access the configuration mode press and hold the 'Set' button. After 2 seconds the minutes will start to flash. Continue holding the button a further 2 seconds until the clock displays in this format: 01 -- 00

In configuration mode the hours digits display the current parameter being adjusted, and the seconds digits display the current value stored against the parameter.

For each parameter, and referring to the table below, scroll through the range of possible values by pressing the 'Up' button. When the desired value has been reached, move on to the next parameter by pressing the 'Set' button. When the last parameter has been set, pressing 'Set' one more time will revert the clock back to time display mode.

Parameter	Description	Values
1	Reserved – leave as 0	
2	12 / 24 Hr mode	0 – 12 Hr (default) 1 – 24 Hr
3	Leading zero blanking	0 – leading zero blanked (default) 1 – leading zero displayed
4	Colon neons mode	0 – AM/PM Indication, flashing (default) 1 – AM/PM Indication, illuminated 2 – Both flash 3 – Both illuminated 4 – Both off
5	Night blanking start hour	0-23 (default 0)
6	Night blanking start minutes	0-59 (default 0)
7	Night blanking stop hour	0-23 (default 0)
8	Night blanking stop minutes	0-59 (default 0)
9	Colon neons mode during night blanking	0 – AM/PM Indication, flashing (default) 1 – AM/PM Indication, illuminated 2 – Both flash 3 – Both illuminated 4 – Both off
10	Reserved – leave as 0	
11	Reserved – leave as 0	
12	Fading Digits Speed	0 – 9 0:fast, 9:slow (0 default)

Setting the time:

From time display mode, press and hold 'Set' button for 2 seconds until the minutes digits start to flash.

Press the 'Up / Reset Secs' button to set the minutes.

Briefly Press 'Set' again and the hours will flash. Press the 'Up / Reset Secs' button to set the hours.

Briefly Press 'Set' again to revert to normal clock operation.

Resetting seconds:

From time display mode, press and hold 'Up / Reset Secs' button for 2 seconds. Seconds will be set to zero, and held until the button is released.

Setting the display mode:

From time display mode, briefly press 'Set' button to toggle between the four display modes:

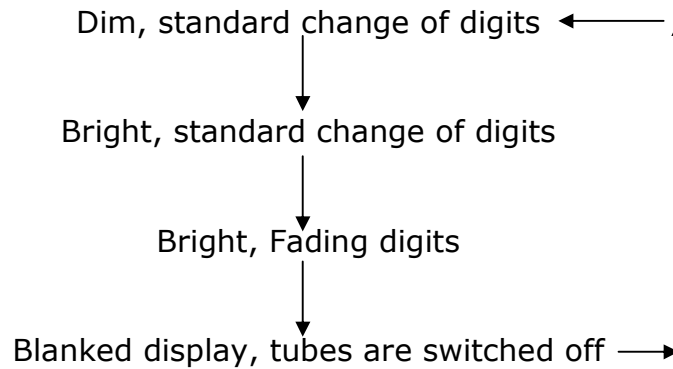

Night Blanking:

During programmed night blanking, the blanking may be overridden to see the time by briefly pressing the 'Set' button. Tubes will remain lit until the next programmed blanking period.

8. CIRCUIT DIAGRAM

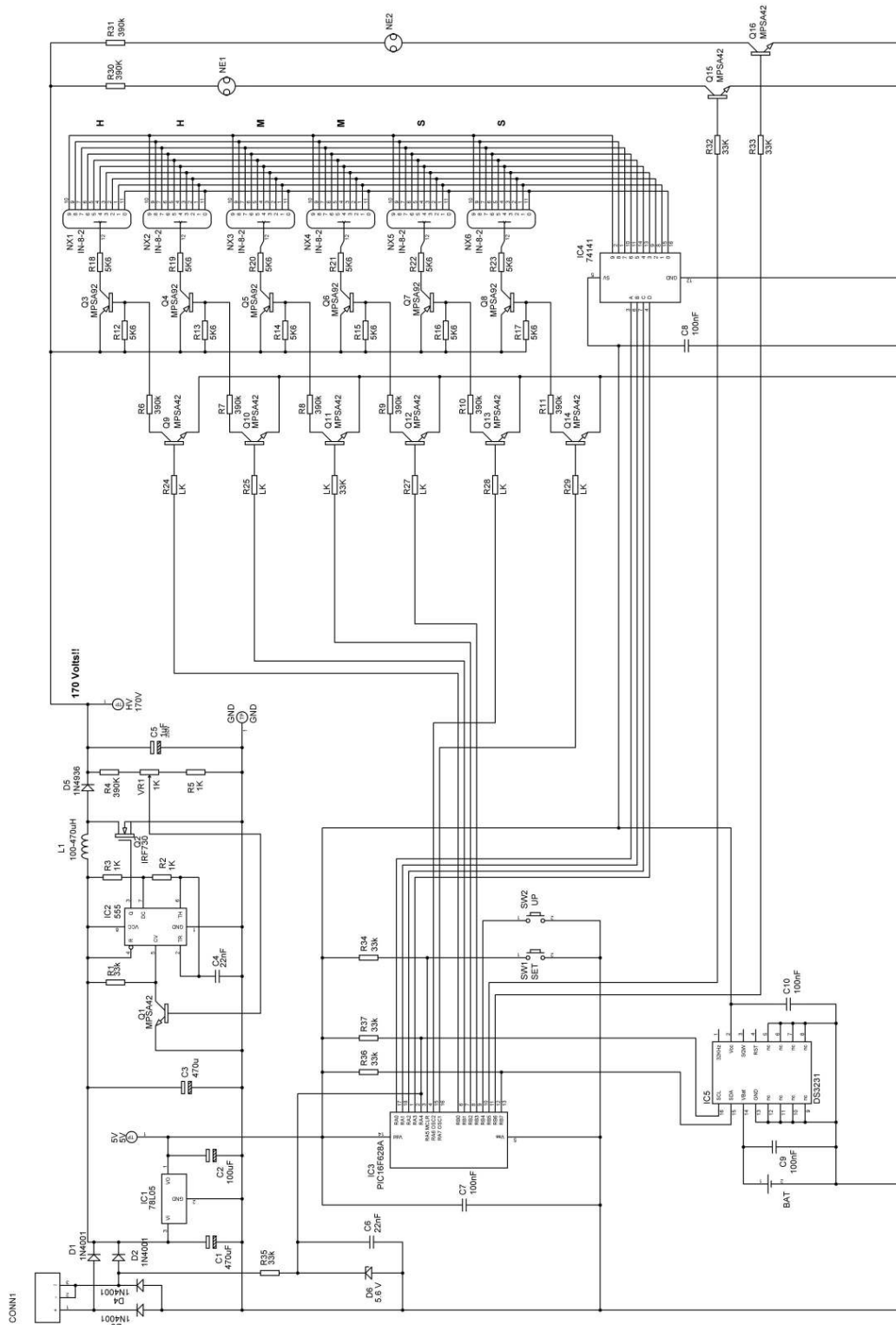

FRANK 2 IN-8-2 Version: 11 April 09